



DOMUSLIFT®
YOUR PERSONAL LIFT



Free from stairs



DomusLift is the elevator designed to meet your vertical mobility needs in both **public and private** buildings. It is the ideal solution for elderly persons and those with impaired mobility who gain independence and freedom from stairs.

Thanks to the new **automatic sliding and folding doors**, the automatic operation can be deployed for a user-friendly use just like any traditional lift.

The special models (**MADE WITH SWAROVSKI® ELEMENTS**, **Light-Touch** by Giugiaro, **Classic**, **Art Line** and **Luxury Collection** with Bisazza mosaic) add exclusive style and elegance, while enhancing any environment.

A wide range of accessories and finishes, as well as the **S-Small** and **XL** versions (designed respectively for small spaces and for a larger car) make DomusLift ideal for any need.



- Quiet and easy to install
- Power consumption like any household electrical appliance
- Connects to any electrical 220-230V outlet
- Requires a small space
- Overcomes architectural barriers
- 3-year warranty
- Available in 54 models, indoor and outdoor

Elegance and style



Being elegant, quiet and discrete allows DomusLift to perfectly fit any new or existing environment.

The elegance of DomusLift is created by the sleek anodised aluminium structure and the standard panoramic glass door which provides optimum light and visibility.

It is a truly modern product, designed and manufactured to meet a wide range of needs and tastes.

From the garage to the roof, DomusLift travels effortlessly up to seven floors.







A user-friendly home

EASY

DomusLift quick installation procedure requires minimum builder's work. The installation also needs limited regulatory approval and benefits from reduced maintenance costs and low energy consumption by using the standard household 230V outlets.

SAFE

With the car being fully enclosed on three sides and the use of internal photocell sensors, passenger safety is always guaranteed. An operating key is located on the pushbutton panel to prevent unauthorised use. In the event of a complete power failure the car is automatically brought to a landing, allowing passengers to safely exit.

ACCESSIBLE

DomusLift is an affordable solution ideal for those with impaired mobility or special needs. The pushbutton control panel is located at a comfortable and accessible height. The remote control provides full operation of the powered door opening and landing calls. The XL version is especially designed to provide you with greater space and load.

RELIABLE

Three-year warranty.

DOMUSLIFT[®]

eco

IGV Group focuses on **energy saving** and is fully committed to the safeguard of the **natural environment**.

DomusLift, the **eco** lifting platform, features a **LED** technology for the car lighting and is available in two versions: traction with **inverter** motor for maximum performance and reduced consumptions, and hydraulic with **100% biodegradable green oil**.



DomusLift has been awarded the prestigious international certification of **Class A energy efficiency** by the German certification body, TÜV Süd.

ALUMINIUM SHAFT STRUCTURE

DomusLift travels inside a robust and elegant aluminium structure, called shaft structure.



MASONRY SHAFT

DomusLift can also be installed within your house. It serves period and modern buildings without affecting their style.



POWER UNIT

The standard controller is provided in a special cabinet of small dimensions (600x280x1250mm). It can be easily concealed in the cellar or garage, because it can be installed up to 7 metres far from the DomusLift.



Functionality everywhere



PUBLIC AREAS

Thanks to DomusLift, shops and restaurants, shopping centres, offices, hotels and factories offer easy access to all levels. Easy and quick to install, DomusLift is the ideal solution for complete mobility within public and working areas.

The wide choice of models and features enables DomusLift to meet any requirement within a new or existing building. Installation flexibility, large service capacity and elegant aesthetics are just some of the DomusLift key features.



EXISTING BUILDINGS

Thanks to its versatility and flexibility, DomusLift is suitable also for the most challenging situations and allows the installation in any architectural context, both in new and existing or historical buildings.

DomusLift is once again the ideal solution for any building with narrow staircase or reduced spaces.



OUTDOOR

The aluminium shaft structure, as an alternative to the masonry shaft structure, allows to place DomusLift anywhere, even outdoor. It guarantees an enhanced usability of spaces without affecting the architectural context.



DomusLift with automatic doors



The DomusLift range grows thanks to the chances offered by the new European Directive 2006/42/EC (Machinery Directive).

DomusLift is now available with sliding automatic 2- or 4-panel doors, featuring a reduced footprint.

The use of automatic doors allows for the elimination of the “hold-to-run” operation by replacing it with the more practical and user-friendly universal automatic operation (APB).

In case of power failure, the automatic return to landing and, optionally, the door automatic opening is carried out.

DomusLift XL

The DomusLift XL series was designed to meet the need for larger cars.

Thanks to the car maximum dimensions up to 1200x1500mm, the XL series offers plenty of space and high load.

The special elegant features of the DomusLift range can be further enhanced by:

- All-glass panels (guide rails wall excluded).
- Wide range of finishes: plastic, painted or stainless steel laminate.

Also available with two adjacent entrances.



DomusLift S

The S-Small series allows the installation of DomusLift even in the narrowest shafts.

The minimum car dimensions up to 580x500mm guarantee enough space for a trouble free movement.

An elegant and refined solution thanks to:

- Seamless single panel walls, without aluminium profile.
- Wide range of finishes: plastic, painted and stainless steel laminate.
- Same accessories as the standard model (where compatible with reduced dimensions).

Same minimum headroom and pit height.

DomusLift

LEATHER WALL

Leather is synonym of class, elegance and superior quality for interior environments and now is also available in the range of DomusLift walls, for the launch of a new concept of luxury.



DomusLift

STATE OF THE ART

From the collaboration of IGV and the Accademia di Belle Arti di Brera, a new and unique combination between industrial design and art. DomusLift wears the Italian flag colours to celebrate the 150th anniversary of Italy unification.



Accademia di
Belle Arti di Brera

+ ItalianArt
Technology

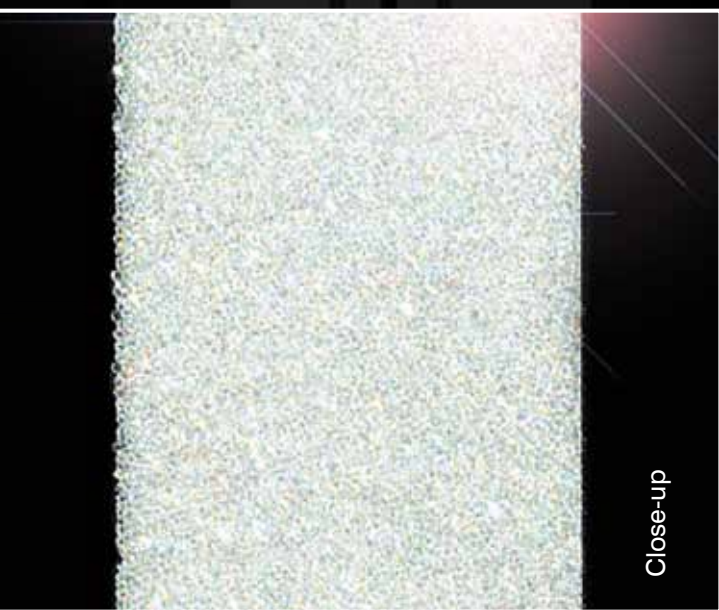

Close-up

Crystal shine, transparency and elegance are combined with high tech design.

A new exclusive DomusLift is born:
DomusLift MADE WITH SWAROVSKI ELEMENTS,
a triumph of steel, glass and SWAROVSKI ELEMENTS.

Designer: arch. Arianna Callocchia

DOMUSLIFT[®]

MADE WITH
SWAROVSKI
ELEMENTS

High-Tech Design

The DomusLift elegance is now further enriched with Giugiaro Architettura innovative lighting system, offering new in-car environments and atmospheres and the subtle sophistication of the touch screen control panel.



lighttouch
by
GIUGIARO
ARCHITETTURA



Classic style

The DomusLift Classic range is designed for those who love the warmth and natural beauty of wood. The “wood effect” is obtained by a special painting method on the aluminium structure.



classic



High-class decor



High-class decor, innovative materials and design create the most aesthetically exclusive personal elevator by combining IGV technology with Bisazza style.



**luxury
collection**
by **BISAZZA**



Artistic homelift



The ART LINE is a highly artistic range. The classic stainless steel carrier becomes a décor component and perfectly fits any environment. It's an all-new trend compared to traditional lifts.



**ART
Line**



Car walls

COATED CHIPBOARD - Standard

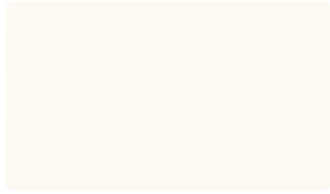

X0003

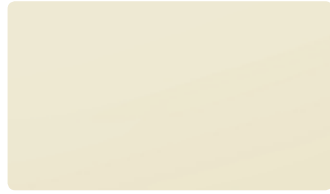

X803



X0034



X817



X1027



X1067



X1024



F9757

SKINPLATE - Standard - Finishes suitable also for shaft structure cladding



DL81E - Wood effect



A90GTA



DL86 - Wood effect



M12



B32SMA



G22SMA



G21SMA



R8SME



A32PP - Polish effect



F2SMA



F42PPS - Brushed stainless steel



F12PPS - Polish stainless steel

STAINLESS STEEL - Finishes suitable also for shaft structure cladding



Mirror 128



Satin 127



Leather 132



Linen 145



Chequered 131



Austenit



Blue squared 150



Polished gold 138

Wide choice of non-standard aesthetical solutions

The colour of the original material may differ from those shown below

Car walls

PLASTIC LAMINATE POLISH EFFECT - Finishes suitable also for shaft structure cladding



0201



0576



0232



0565



0606



0605



0641



0614



0594



0675



0564



0543

PLASTIC LAMINATE WOOD EFFECT - Finishes suitable also for shaft structure cladding



4327



4176



1971

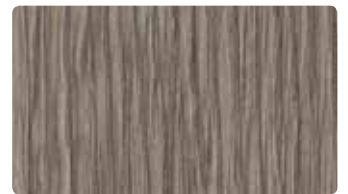

4516



1834



1835

Wide choice of non-standard aesthetical solutions

The colour of the original material may differ from those shown below



DomusLift Configurator

Browse our Website www.domuslift.com and click CONFIGURATOR.

A wide selection of colours and materials designed by our designers is available for the creation the ideal DomusLift for your environment!

Car floors

LINOLEUM



Marmoleum 3861 Arabian pearl



Marmoleum 3874 Walnut



Marmoleum 3866 Eternity

PVC



Eternal 12802 Elegant oak



Eternal 11562 Tropical beech



Eternal 11492 Warm cherry



Eternal 12662 Merbau



Eternal 11522 Black Oak

RUBBER



Grey rubber with dots



Smooth grey rubber



Black rubber with dots

GRANIT



Granit Rocksolid 607



Granit T2402



Granit Rocksolid 671



Granit Titan Grey

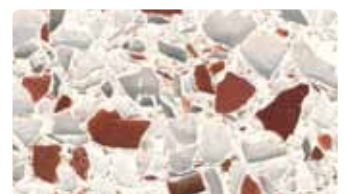

Granit Cristallino 451

Wide choice of non-standard aesthetical solutions

Car profiles, doors and shaft structure

Anodized aluminium



Natural aluminium - Standard



Polished



Nickel



Copper



Moka



Polished black

Painted aluminium with wood effect or RAL colours



Cherry



Decò style white



9010 7001



5023 5011

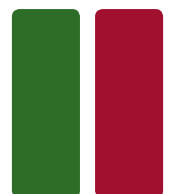

6010 3003

The colour of the original material may differ from those shown below

Car walls and shaft structure

GLASS



Transparent



Milk white



Coloured



Smoked

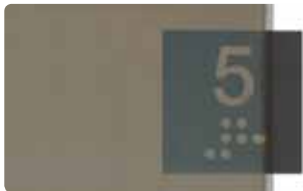

Stopsol



Mirror



Self-cleaning glass



Photovoltaic cells in safety stratified glass.



Serigraph effect

A special covering for outdoor applications promote:

- Break up of organic material under the effect of sunlight.
- Greater water run off removing dirt.

Full design freedom for glass measures, transparencies or colours.
Only for outdoors.

Wide choice of non-standard aesthetical solutions

Car lightings



Halogen spot



LED spotlights



Firmament



Floral



Car lighting with white ceiling
- Standard



Car lighting with black ceiling
- Standard

The colour of the original material may differ from those shown below



ACCESSORIES

- Fully operational remote control (call, door opening and floor change)
- Automatic door opening
- Retractable door closer
- Voice synthesiser when stopping at a landing
- Phone alarm device
- Gong (sound signal at landing)
- Full-height infra-red barriers (photocells are standard)
- Telephone

Pushbuttons and pushbutton panels

Standard pushbutton



Maxi pushbutton



CAR PUSHBUTTON PANELS



Standard
Stainless steel



Touch screen
with domotic
interface

LANDING PUSHBUTTON PANELS

Stainless steel - Standard



Golden stainless steel



Embedded in the round polish
stainless steel handrail



Module



Embedded in the flat handrail



Polish/brushed stainless steel
or wood effect



Pine



Dark walnut

Display



CAR DISPLAY
Tricolor - Only for module



CAR AND LANDING DISPLAY
Icaro

Door handle



Standard
Natural
anodised
aluminium



Golden

Handrail

Flat



Rounded



Doors

SWING LANDING DOORS



B PANORAMIC ALUMINIUM

Standard door with retractable door closer, aluminium profiles and wide glass window

FINISHES

- Anodised aluminium
- RAL painted



C1 BLIND

Fire-rated doors type: C2 - EI 120

Steel door

FINISHES

- Primed
- RAL painted
- Coated



D VISION PANEL

Fire-rated doors type:

- D1 - BELGIUM
- D2 - BS476 - UK
- D3 - E120
- D4 - EW60

Steel and glass door

FINISHES

- Primed
- RAL painted



E PANORAMIC IRON

Steel and glass door

FINISHES

- Primed
- RAL painted



V1 PANORAMIC

Total glass door

FINISHES

- Stainless steel

Wide choice of non-standard aesthetical solutions

AUTOMATIC LANDING AND CAR DOORS

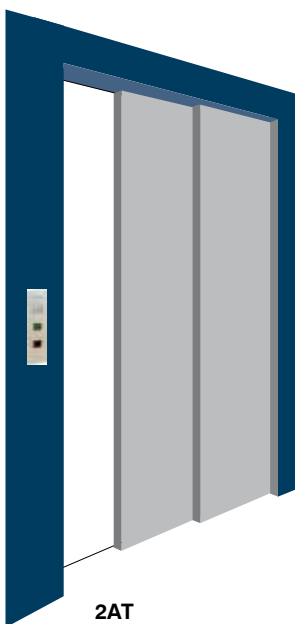

2AT
2 telescopic panels with side opening

FINISHES

- Primed
- RAL painted
- Coated

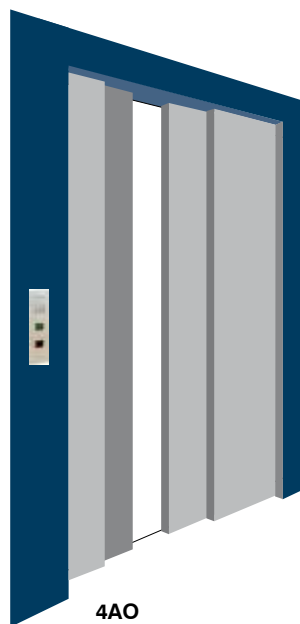

4AO
2 telescopic panels with central opening

FINISHES

- Primed
- RAL painted
- Coated

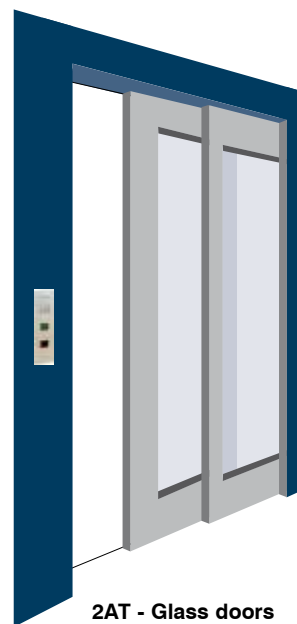

2AT - Glass doors
2 telescopic panels with side opening

FINISHES

- Primed
- RAL painted
- Coated

FOLDING DOORS

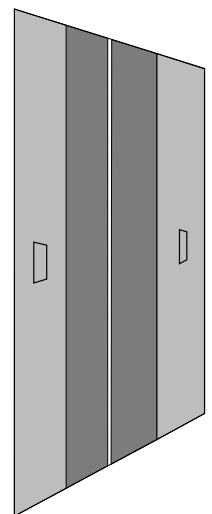

Folding automatic door installed inside the car. It can be matched with automatic swing landing doors

The colour of the original material may differ from those shown below

Technical features

GEARLESS ELECTRIC WITH COUNTERWEIGHT

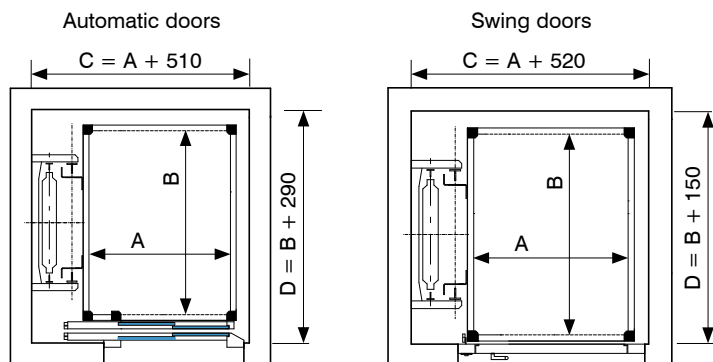

Dim. min (AxB) 800 x 1100 mm
Dim. max (AxB) 1100 x 1400 mm

Dim. min (AxB) 800 x 1000 mm
Dim. max (AxB) 1100 x 1400 mm

- Complying with 42/2006/EC Machinery Directive
- Machine roomless (MRL)
- Gearless machine, with counterweight
- Load up to 400 kg
- Stops: 7; Travel: 20 m
- Pit: 200 mm; Headroom: 2900 mm
- With automatic telescopic doors or without car doors
- Glass doors and panels
- Opposite double access and adjacent
- Extremely silent
- High ride comfort
- Minimum consumptions
- Masonry shaft or shaft structure
- Speed: 0.15 m/s max
- Cabinet dimensions: 600 x 280 x 1250 mm

TRACTION GEARED WITH COUNTERWEIGHT

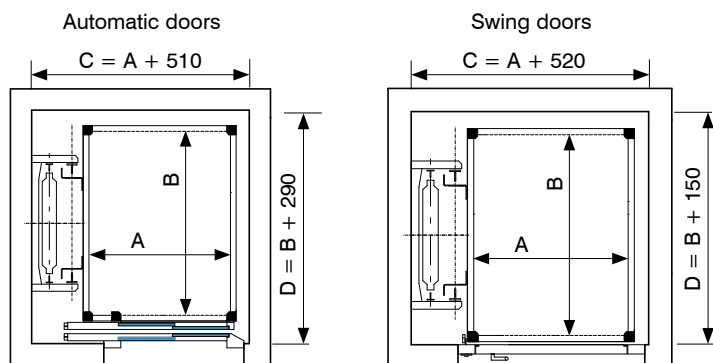

Dim. min (AxB) 800 x 1100 mm
Dim. max (AxB) 1100 x 1400 mm

Dim. min (AxB) 800 x 1000 mm
Dim. max (AxB) 1100 x 1400 mm

- Complying with 42/2006/EC Machinery Directive
- Machine roomless (MRL)
- Geared machine with counterweight
- Load up to 400 kg
- Stops: 7; Travel: 20 m
- Pit: 200 mm; Headroom: 2900 mm
- With automatic telescopic doors or without car doors
- Glass doors and panels
- Opposite double access and adjacent
- Superior ride comfort
- Reduced consumptions
- Masonry shaft or shaft structure
- Speed: 0.15 m/s max
- Cabinet dimensions: 600 x 280 x 1250 mm

TRACTION DRUM WITHOUT COUNTERWEIGHT

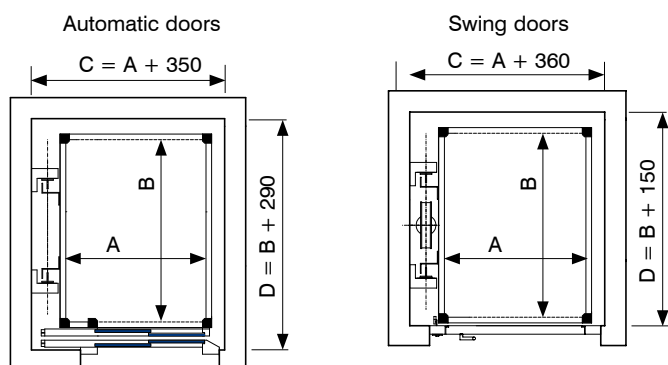

Dim. min (AxB) 800 x 1000 mm
Dim. max (AxB) 1000 x 1300 mm

Dim. min (AxB) 800 x 800 mm
Dim. max (AxB) 1000 x 1300 mm

- Complying with 42/2006/EC Machinery Directive
- Machine roomless (MRL)
- Drum geared machine without counterweight
- Load up to 300 kg
- Travel: 6 m max
- Pit: 150 mm; Headroom: 2600 mm
- With automatic telescopic doors or without car doors
- Glass doors and panels
- Opposite double access and adjacent
- Same dimensions as hydraulic version
- Masonry shaft or shaft structure
- Speed: 0.15 m/s max
- Cabinet dimensions: 600 x 280 x 1250 mm

HYDRAULIC

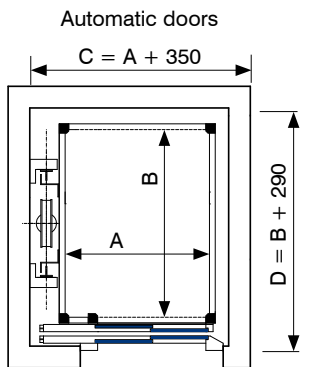

Dim. min (AxB) 800 x 1000 mm
Dim. max (AxB) 1100 x 1400 mm

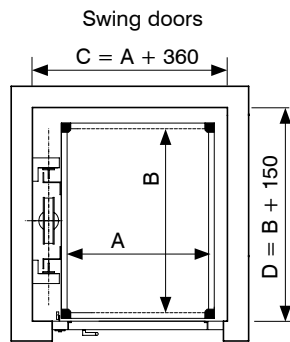

Dim. min (AxB) 800 x 800 mm
Dim. max (AxB) 1000 x 1300 mm

- Complying with 42/2006/EC Machinery Directive
- Machine roomless hydraulic drive
- Direct telescopic suspension or roping version
- Load up to 300 kg
- Stops: up to 7; Travel: 12 m
- Pit starting from 55 mm, headroom from 2350 mm
- With automatic telescopic doors or without car doors
- Glass doors and panels
- Opposite double access and adjacent
- Minimum dimensions
- Silent and easy to install
- Masonry shaft or shaft structure
- Speed: 0.15 m/s max
- Cabinet dimensions: 600 x 280 x 1250 mm

DomusLift S

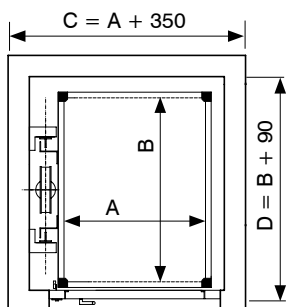

Dim. min (AxB) 580 x 550 mm
Dim. max (AxB) 800 x 800 mm
(Variable dimensions based on geometry)

DomusLift XL

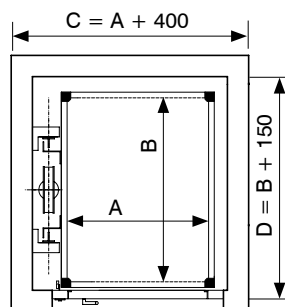

Dim. min (AxB) 800 x 1200 mm
Dim. max (AxB) 1200 x 1500 mm

Special features for XL model:

- Pit: 120 mm min
- Headroom: 2500 mm min
- Stops: up to 7; travel: 17 m
- Rated power: 2.2 kW for 400 kg load
- 1 or 2-piece ram

Cabinet dimensions with power unit and controller (for XL model):

- 720 x 360 x h. 1500 mm (closed), 720 x 1050 x h. 1500 mm (open) for travels up to 12 m
 - 950 x 400 x h. 1850 mm (closed), 950 x 850 x h. 1850 mm (open) for travels > 12 m
- Glass car panel available for all car walls (car sling side excluded) and maximum dimension of 1500 mm.

3 ENTRANCE Model

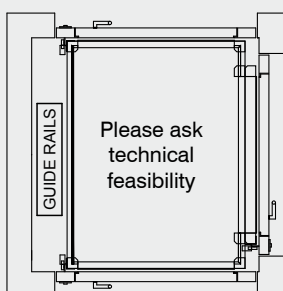

2 ADJACENT ACCESS Version

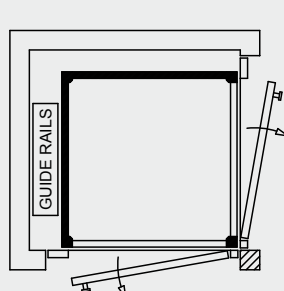

2 OPPOSITE ACCESS Version

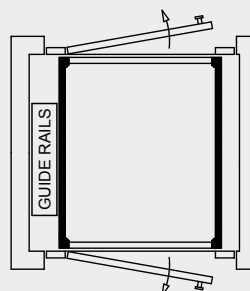

Special version with 55-mm pit (2520 mm headroom)



A wide range is available with dimensions different from the standard models.



Equipment type-approved to transport impaired persons.



DomusLift requires a pit of 100 mm (upon request 55 mm with 2520 mm headroom) or an access ramp. A 2450 mm headroom is enough for a tackle ram system and 2350 mm for telescopic ram.



The DomusLift lifting platform complies with 2006/42/EC Machinery Directive and with all current requirements.

made in
Italy

IGV

Lifts since 1966



Certified by



Member of



ED 10/2011

I.P.



www.domuslift.com



IGV Group SpA

Via Di Vittorio, 21
20060 Vignate, Milan - Italy

Tel. +39 02 951271

Fax +39 02 9560423

www.igvlift.com

www.domuslift.com